

Owner's Manual



➤ P326D



➤ P326A

Table of Contents

Introduction

Practice Before Operating	2
---------------------------------	---

Safety Instructions

Safety Considerations	4
Driving Outdoors	8
Driving on Various Terrains	10

Familiarize Yourself With Your Powerbase Wheelchair

Feature Diagram	12
Specification	14
Terminology	15
Disassembly of the Powerbase Wheelchair	16

Adjusting For Comfort

Adjusting the Seat Height	17
Adjusting the Armrest Angle	18
Adjusting the Footrest Angle	18
Adjusting the Headrest Height	18
Adjusting the Joystick Position	18
Adjusting the Footrest Position(P326D)	18

Operating Your Powerbase Wheelchair

Manual Freewheel Levers	19
DK-REMD Controller Operation	20
DK-REMD 11 Controller Operation(P326D)	25
Dynamic Shark Controller Operation	26
VR2 Controller Operation	34
LiNX Controller Operation	39
Batteries and Charging	47

lec Symbols	49
-------------------	----

Warranty

Limited Warranty	50
------------------------	----



Welcome aboard your new powerbase wheelchair, and thank you for choosing our product. Please read this manual carefully, and follow all instructions before attempting to operate your powerbase wheelchair for the first time. If there is anything in this manual that you do not understand, or if you require additional assistance for setting up your powerbase wheelchair, please contact your local dealer.

This latest model is designed for specific practical user needs, combining solid, rugged construction, and modern high-tech electronics, to enhance safety and performance.

With a state-of-the-art, programmable electronic control system, your powerbase wheelchair can be programmed and adjusted within a given range of its performance characteristics, to suit your individual needs. The controller is set up at the factory to give the powerbase wheelchair nominal operating performance characteristics.

After becoming familiar with the basic operation of the powerbase wheelchair, you may wish to customize the settings to fit your own personal preferences. A wide range of customization options can be adjusted such as acceleration, deceleration, maximum speed, turning speed, safety controls, better maneuverability of the joystick, and so on. Contact your local dealer for advice on additional equipment you may need.

Having your powerbase wheelchair checked regularly by your local dealer is the best way to ensure smooth operation, and safety.

This manual provides users practical tips and information on safety issues, operation, and maintenance. Please read it very carefully to ensure your maximum enjoyment and to fully benefit from your independence and mobility.

Whenever special advice or attention is needed, please do not hesitate to contact your local dealer, who has the tools and know-how to provide expert servicing for your powerbase wheelchair.

Your satisfaction and opinions are highly valued by both your local dealer and our company. Please be sure to fill out the enclosed guarantee form, and return it to your local dealer. The information is necessary for providing you with the best service, and to help us ensure that all of your needs are met.

Failure to follow these instructions may result in damage to the powerbase wheelchair or serious injury.

■ Practice Before Operating

Find an open area such as a park and have an assistant to help you practice until you have confidence operating this vehicle.

Make sure that the power is off before getting in or out of the seat. Set the speed control button according to your driving ability.

We recommend that you keep the speed control at the slowest position until you are familiar with the driving characteristics of this vehicle.

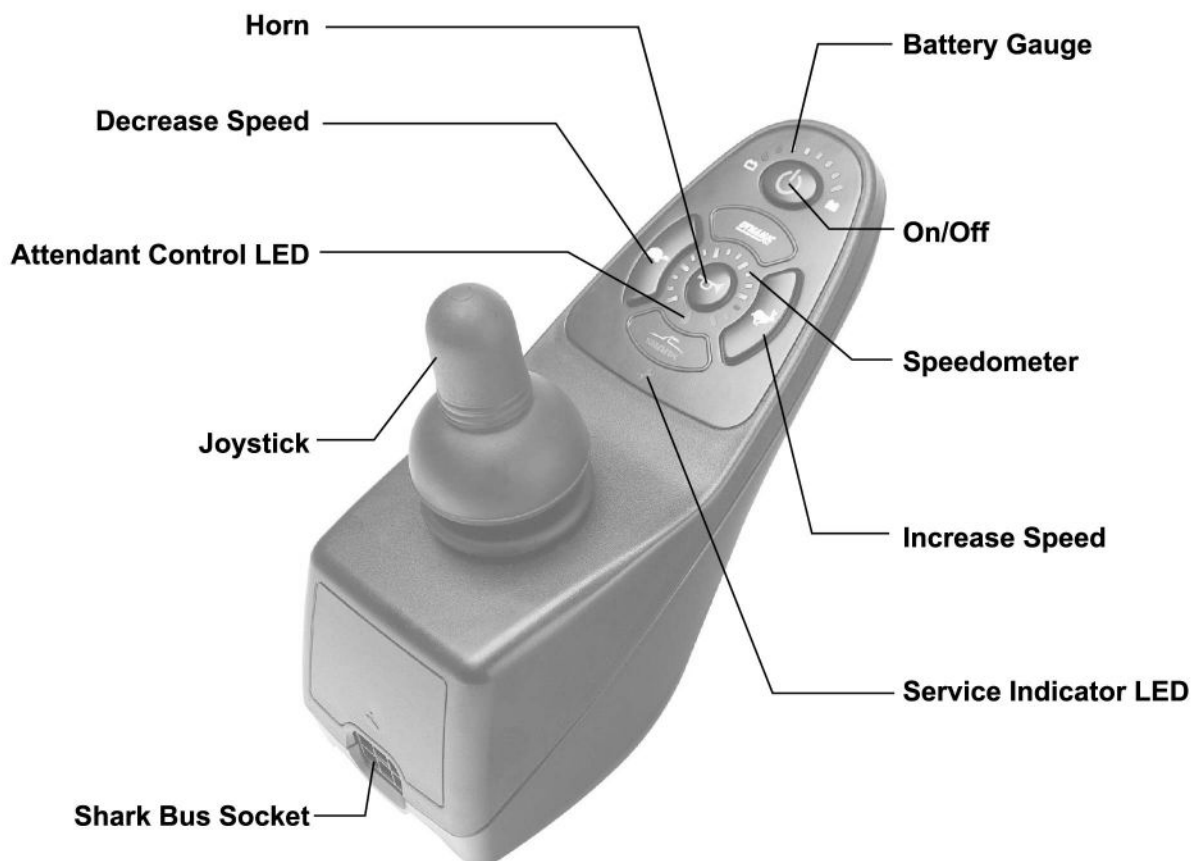

Getting familiar with this vehicle



**First, practice moving forward.
Be sure to set the speed to the lowest setting.**



**After becoming familiar with moving forward,
practice marking "S" turns.**



**Once you are familiar with "S" turns, practice
moving in reverse. Note that at any speed control
setting, the vehicle moves more slowly in reverse
than forward**

■ Safety Considerations

DO NOT do any of the following



NO!

Do not carry any passengers



NO!

Do not drive across a slope



NO!

Do not drink and drive
Consult your physician to
determine, if your medications
impair your ability to control this
vehicle



NO!

Do not tow a trailer



NO!

Do not turn on or use hand-held personal
communication devices such as citizens band(CB)
radios and cellular phones



NO! For P326D

When lift the seat, please pay attention to the following:

1. Do not drive off-road or on any uneven surfaced roads.
2. Do not attempt to climb any curbs.
3. Do not attempt to cross any gap.
4. Do not attempt to climb any ramp.
5. Do not attempt to recline over 105°.



NO! For P326D

Do not step on the footrest when mounting or dismounting the unit. Failure to observe this may tip the power chair forward and could result in body injury.

This vehicle has an immunity level of 30 v/m which should protect it from Electromagnetic Interference(EMI) from radio wave sources. The rapid development of electronics, especially in the area of communications, has saturated our environment with electromagnetic (radio) waves that are emitted by television, radio and communication signals. These EM waves are invisible and their strength increases as one approaches the source. All electrical conductors act as antennas to the EM signals and, to varying degrees, all power wheelchairs and power scooters are susceptible to electromagnetic interference (EMI). This interference could result in abnormal, unintentional movement and/or erratic control of the vehicle. The United Statement be incorporated to the user's manual for all electric power wheelchairs.

Powered wheelchairs and electric power scooters (in this text, both will be referred to as powered wheelchairs) may be susceptible to electromagnetic interference (EMI), which is interfering electromagnetic energy emitted from sources such as radio stations, TV stations, amateur radio (HAM) transmitters, two-way radios and cellular phones. The interference (from radio wave sources) can cause the powered wheelchair to release its brakes, move by itself or move in unintended directions. It can also permanently damage the powered wheelchair's control system. The intensity of the EM energy can be measured in volts per meter(V/m). Each powered wheelchair can resist EM up to a certain intensity. This is called the "immunity level." The higher the immunity level, the greater the protection. At this time, current technology is capable of providing at least 30 V/m of immunity level which would provide useful protection against common sources of radiated EMI.

Following the warnings listed below should reduce the chance of unintended brake release or powered wheelchair movement that could result in serious injury:

- 1) Do not turn on hand-held personal communication devices such as citizens band (CB) radios and cellular phones while the powered wheelchair is turned on.
- 2) Be aware of nearby transmitters such as radio or TV stations and try to avoid coming close to them.

- 3) If unintended movement or brake release occurs, turn the powered wheelchair off as soon as it is safe.
- 4) Be aware that adding accessories or components, or modifying the powered wheelchair, may make it more susceptible to interference from radio wave sources. (Note: there is no easy way to evaluate their effect on the overall immunity of the powered wheelchair).
- 5) Report all incidents of unintended movement or brake release to the powered wheelchair manufacturer, and note whether there is a radio wave source nearby.

TURN OFF YOUR POWER WHEELCHAIR AS SOON AS POSSIBLE WHEN EXPERIENCING ANY OF THE FOLLOWING:

1. Unintentional motions.
2. Unintended or uncontrollable direction.
3. Unexpected brake release.

The FDA has written to the manufacturers of power wheelchairs, asking them to test their new products to be sure they provide a reasonable degree of immunity against EMI. The letter says that powered wheelchairs should have an immunity level of at least 30 V/m, which provide a reasonable degree of protection against the more common sources of EMI. The higher the level, the greater the protection.

■ Driving Outdoors

When driving outdoors, please pay attention to the following:



NO!

Do not drive in traffic.



NO!

Do not drive beside a river, port, or lake without a fence or railing.



NO!

If possible, do not drive during the rain.



NO!

If possible, do not drive during or on snow.



NO!

Do not drive off-road or on any uneven surfaced roads.



NO!

If possible, do not drive at night.



NO!

Make sure that there are no obstacles behind you when in reverse.

We recommend to set the speed at the lowest setting for reversing.



NO!

Do not make sudden stops, weave erratically, or make sharp turns.



NO!

Keep your arms on or inside the armrests and feet on the footrest at all times.



NO!

Do not attempt to climb curbs greater than $1\frac{1}{2}$ "(4cm).

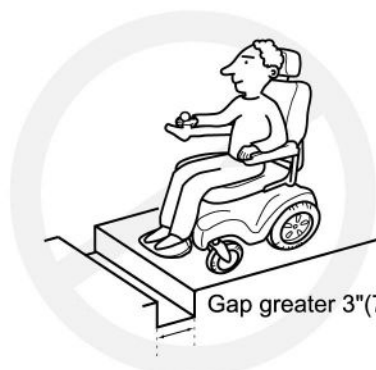

NO!

Do not attempt to cross over a gap greater than 3"(7.5cm).

Gap greater 3"(7.5cm)

■ Driving on Various Terrains

Driving up and down ramps or inclines is more dangerous than on level surfaces. If you fail to heed these warnings, a fall, tip-over or loss of control may occur and cause severe injury to the vehicle user or others.



NO!

Do not attempt to climb a ramp or incline greater than 6°



NO!

Do not reverse while driving up a ramp or incline.

Forward only. If you reverse while moving up a ramp or incline, it may cause the vehicle to tip over.



NO!

Do not attempt to drive across a sloping surface greater than 3°

Driving across a slope greater than 3° is very dangerous and may cause the vehicle to tip over.



NO!

Do not drive over soft, uneven or unprotected surfaces such as grass, gravel and decks.



NO!

Use low speed while driving down ramp.

When braking while moving down ramp, the wheelchair will take longer to come to a complete stop.



NO!

Do not get on and off on a ramp.

Always stop on the level surface to get in and get out of the vehicle.



YES!

Always climb or descend gradients perpendicular to the slope or ramp.

Owner's Manual

Familiarize yourself with your powerbase wheelchair

■ Feature Diagram

In this section, we will acquaint you with the many features of your powerbase wheelchair and how they work. Upon receipt of your powerbase wheelchair, inspect it for any damage. Your powerbase wheelchair consists of the following components.



P326A



P326D

■ Micro Compact Powerbase Wheelchair Specifications



P326A



P326D

Model No.	P326A	P326D
Length	34" (86cm)	
Width	24" (61cm)	
Seat Width	18" (46cm) / 20" (51cm)	
Seat Height(from deck)	17"~21"(43~53cm)	15.5"~19.5"(39~50cm)
Seat Height(from ground)	21.5"~23.5"(55~60cm)	22"~29.5"(56~75cm)
Speed	8 kph (5 mph)	
Range up to	28 km (18 mi)	
Weight Capacity	136 kg (300 lbs)	
Total Weight(without battery)	60kg (132 lbs)	66kg (145 lbs)
Motor	DC24V / 160W	
Brake	Intelligent, regenerative, electromagnetic brake	
Controller	Dynamic Shark 40A PG VR2 40A Dynamic LiNX 40A	Dynamic Shark 60A
Battery	12V / U1* 2 pcs	
Charger	4A off board	
Gradient	6°	
Caster Wheel	F:6" / R:6" Solid tire	
Drive Wheel	10" tire	

■ Terminology

Joystick: The device used to "move" the powerbase wheelchair.

Controller: The device that allows the joystick to function. Not all joysticks have a controller.

Armrests: Where arms can rest during time spent on powerbase wheelchair.

Footrest: Where feet rest during time spent on the powerbase wheelchair.

Drive Wheel: The wheels that move the powerbase wheelchair. These are the main wheels.

Caster Wheel: The front wheels and the rear wheels.

Controller Harness : Cable connecting the joystick to the controller.

Freewheel Lever: For convenience, your powerbase wheelchair is equipped with freewheel levers. These levers allow you to disengage the drive motors and maneuver the chair manually.

Seat Lift : Power seat elevator available.



WARNING: DO NOT use the powerbase wheelchair without the presence of an attendant while the drive motors are disengaged! **DO NOT** disengage the drive motors when your powerbase wheelchair is on an incline, as the chair could roll down on its own, causing injury!

To engage or disengage the drive motors:

1. Turn the freewheel levers upward to disengage the drive motors.
2. Turn the freewheel levers downward of the powerbase wheelchair to engage the drive motors.

Note: It is important to remember that when the powerbase wheelchair is in the freewheel mode, the braking system is disengaged.

■ Disassembly of the Powerbase wheelchair

Seat Remove:

For P326A

- (1) Disconnect the controller plug. (Fig A)
- (2) Turn the seat lock-handle up. (Fig B)
- (3) Lift seat up. (Fig C)

For P326D

- (1) Disconnect the controller plug. (Fig A)
- (2) Lift seat up. (Fig C)



Fig A



Fig B



Fig C

Remove Battery:

- (1) Turn the four plastic lock pins then remove shroud. (Fig D.E.F.)
- (2) Unfasten the reusable fastener. (Fig G)
- (3) Disconnect the battery wire. (Fig H)
- (4) Remove the batteries. (Fig I)



Fig D

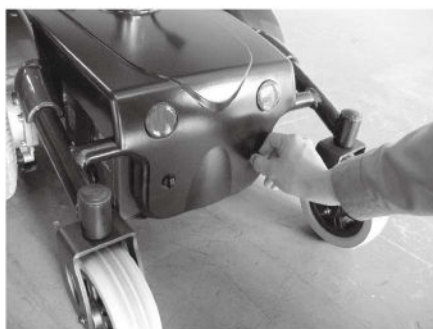

Fig E



Fig F



Fig G



Fig H



Fig I

Seat Height Adjustment:

For P326A

- (1) Hold hexagonal bolt with a 17mm wrench and loosen the nut. (Fig J)
- (2) Choose the right height and Tighten the bolt.

For P326D

Please to refer P25.



Fig J

Armrest Angle Adjustment:

1. Flip up the armrest for easy access.
2. Turn the set screw counter-clockwise to raise the armrest and clockwise to lower the front of armrest (Fig K).



Fig K

Footrest Angle Adjustment:

1. Flip-up the footplate for easy access (Fig L).
2. With an Allen wrench, simply turn the bolt clockwise to increase the angle or counter-clockwise to decrease it (Fig L).
 - (1) Hold hexagonal bolt with wrench and loosen the nut. (Fig L)
 - (2) Choose the right angle and tighten the bolt.

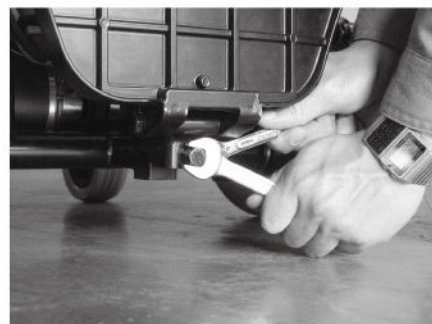

Fig L

Headrest Height Adjustment:

Depress then release the clamp on the left of backrest while pulling headrest up or pushing down until you reach the desired position (one of three). (Fig M)



Fig M

Joystick Position Adjustment:

Loosen the set screw with allen key and adjust the joystick bar to right position. then tighten. (Fig N)



Fig N

Footrest Position Adjustment (P326D)

- (1) Put the Footrest in the tube.(Fig O)
- (2) Put in the plug. (Fig O)
- (3) Adjust the footrest to forward or backward, and then tighten the knob. (Fig O)

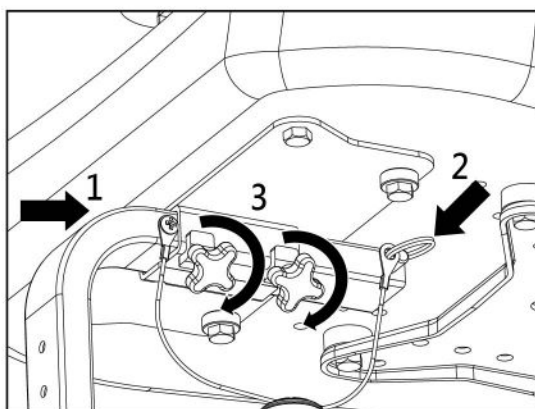

Fig O

■ Manual Freewheel Levers:

The powerbase wheelchair has a manual freewheel lever on each motor. Manual freewheel levers enable you to disengage the drive motors from the gearboxes and maneuver the chair manually.



WARNING! Do not use the powerbase wheelchair while the drive motors are disengaged! Do not disengage the drive motors when the powerbase wheelchair is on an incline, as the unit could roll on its own, causing injury!

To engage or disengage the drive motors:

1. Locate the lever on top of each motor.
2. Push the two levers downward to engage the drive motors.(Fig P)
3. Pull the two levers upward to disengage the drive motors.(Fig Q)

If a lever is difficult to move in either direction, slightly rock the powerbase wheelchair back and forth. The lever should then move to the desired position.



WARNING! It is important to remember that when your powerbase wheelchair is in freewheel mode, the braking system is disengaged.

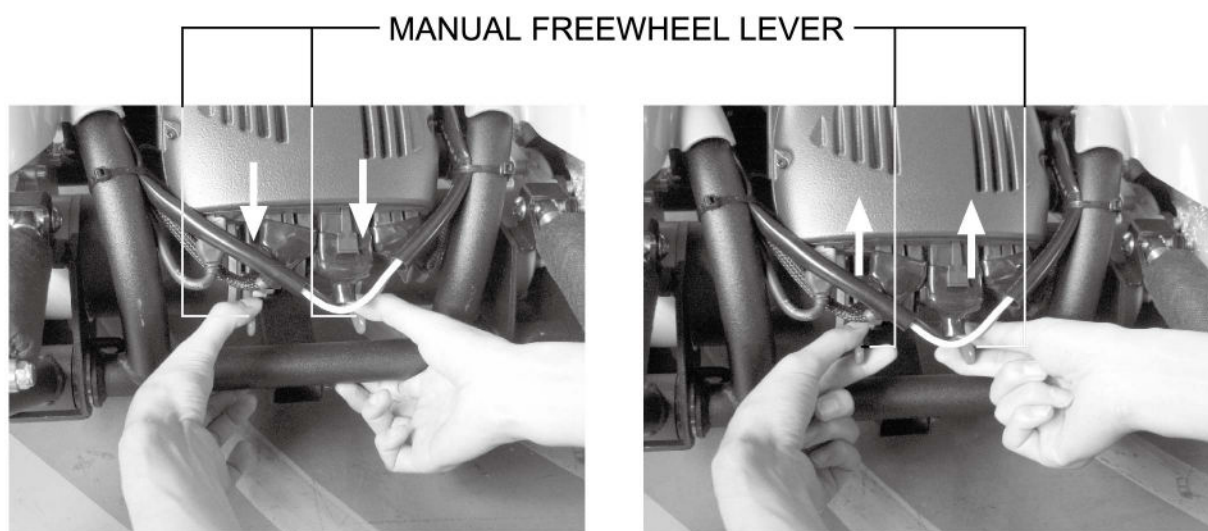
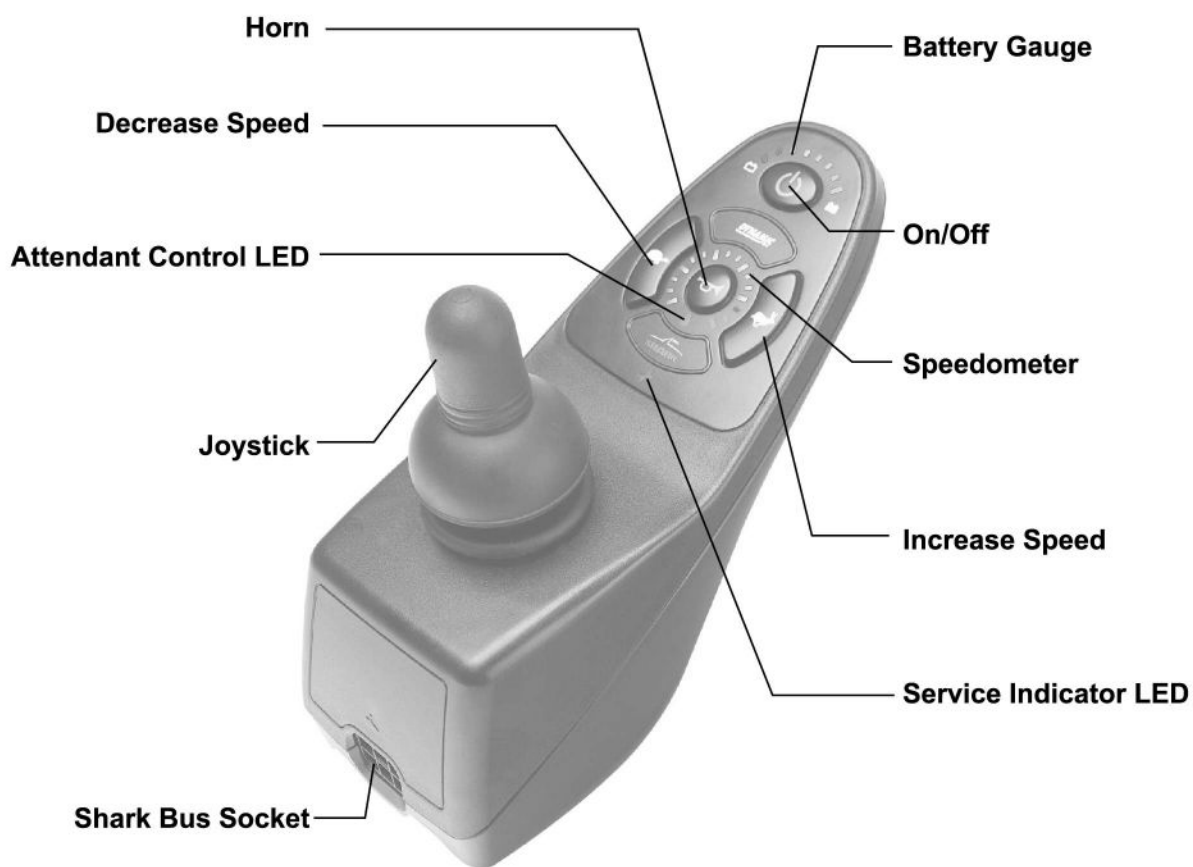

Fig P. Drive Mode (Drive Engaged)

Fig Q. Freewheel Mode (Drive Disengaged)

DK-REMD Controller Operation



1. Turning SHARK On/Off and the Sleep Feature

Turning the Power ON

	<p>Press the On/Off button.</p> <p>All Battery Gauge indicators will light briefly.</p> <p>Either the current battery charge or Lock Mode will then be indicated.</p>
---	---

Turning the Power OFF

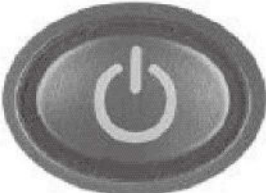
	<p>Press the Power button.</p> <p>All LED's will turn off.</p>
---	--

2. Adjusting the Driving Speed

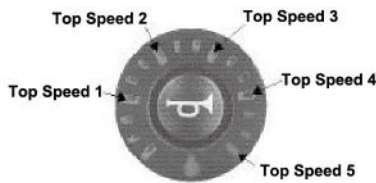
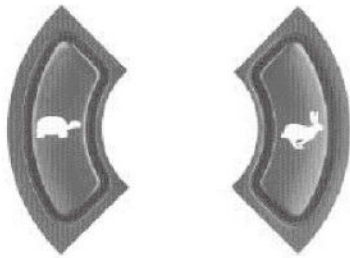

Top Speed 1

Typically 20% but programmable using the Lowest Forward Speed parameter.

Top Speed 5

Typically 100% but programmable using the Maximum Forward Speed parameter.

The user can adjust the chair's top speed to suit their preferences and environment. The currently selected top speed is shown on the Speedometer and can be adjusted using the "Increase Speed" (Hare) and "Decrease Speed" (Tortoise) buttons.

Each of the speedometer's 6 large LEDs typically represent 0%, 20%, 40%, 60%, 80% and 100% of the chair's absolute maximum top speed

REMD supports 2 modes of top speed adjustment - "5 Speed" and "VSP" modes.

In the "5 Speed" mode pressing the Increase Speed and Decrease Speed buttons steps between one of the 5 top speeds 20% to 100%.

In the "VSP" mode a quick single press of the Increase Speed and Decrease Speed buttons also steps between one of the 5 speeds 20% to 100%. However, pressing and holding the Increase Speed (Decrease Speed) Button ramps the top Speed up (down) in fine steps, allowing practically any top speed to be selected. This can be particularly useful for matching the chair speed to the walking speed of an accompanying pedestrian.

VSP is an extremely powerful feature, allowing both fast stepping between fixed top speeds by using quick presses or finer control using long presses. The VSP feature can be enabled or disabled. Users can toggle between the "VSP" and "5 Speed" Modes by holding down both the Increase Speed and Decrease Speed Buttons for approximately 2 seconds while the unit is powered up. The control unit will beep when the mode has been changed.

3. Using the Speedometer

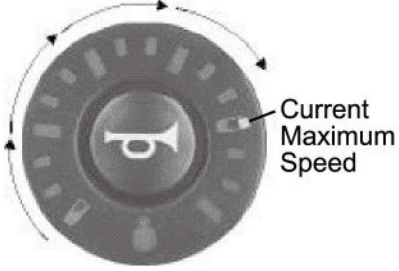
	<p>The Speedometer is used to gauge the relative speed of the chair in comparison to the maximum speed possible. The right -most LED indicates current maximum speed, which can be adjusted using the Increase (Decrease) Speed button. Refer to section 2.3 for further details. Using the joystick, as the speed of the chair increases, the LED's will fill in until maximum speed (as displayed) is reached.</p> <p>If the bottom, left -most GREEN LED is flashing SHARK is in SPEED LIMIT mode, which limits the drive speed to a pre-programmed value, typically when a seat is raised or tilted and driving too fast may be dangerous. Reference your SHARK Power Module Installation Manual for further details.</p>
---	---





4. Using the Horn

	<p>Press the Horn button.</p> <p>The horn will sound for as long as the button is pressed.</p>
---	--

5. The SHARK Battery Gauge

	<p>The Battery Gauge is used to indicate power on (refer 2) and provides an estimate of the remaining battery capacity.</p> <p>Any green LEDs lit indicate well charged batteries.</p> <p>If only amber and red LEDs are lit, the batteries are moderately charged. Recharge before undertaking a long trip.</p> <p>If only red LEDs are lit, the batteries are running out of charge. Recharge as soon as possible.</p>
---	---

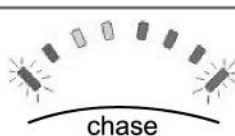
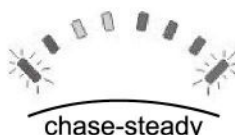
The following table indicates what the gauge will display for any given state.

Display	Description	This means...	Notes
	All LED's OFF	Power is OFF	
	All LED's ON steady	Power is ON	Less LED's imply a reduced battery charge.
	Left RED LED is flashing	Battery charge is low	The batteries should be charged as soon as possible.
	Right to left 'chase'	SHARK is being brought out of Lock mode	To unlock SHARK, press the Horn button twice within 10 seconds.
	Left to right 'chase' alternating with steady display	SHARK is in program ming, inhibit and/or charging mode	The steady LED's indicate the current state of battery charge.
	All LED's flashing slowly	SHARK has detected an Out Of Neutral At Power Up (OONAPU) condition	Release the joystick back to neutral.

6. The REMD Service Indicator Light

	The amber Service Indicator LED is dedicated to displaying SHARK Flash Codes. For a list of the Flash Codes and what faults they indicate, Reference Section 5.3.
---	---

7. Using the Joystick

	Moving the joystick will cause the powerchair to drive in that direction. The amount of joystick movement will determine the speed that the powerchair will move in that direction.
---	---

8. The Fault Indicator - Flash Codes

If a fault condition exists, the Fault Indicator LED shows a Flash Code. A flash code is a specific number of short flashes, followed by a pause.



If the fault is a serious fault that prevents the chair from driving, additionally the Battery Gauge shows a 'Drive Inhibit' indication.



Flash Code	Fault source	Meaning
1	Route / Temperature	<p>The motor current has been at the maximum value for too long.</p> <ul style="list-style-type: none"> The motors may not be strong enough for the chosen route (the route is too steep). <ul style="list-style-type: none"> Turn off the SHARK, let it cool down, then turn it back on again and choose another route. The wheels may be rubbing on the frame. <ul style="list-style-type: none"> Make sure that the wheels can turn freely. The motors may be faulty. <ul style="list-style-type: none"> Have the motor(s) checked by a service technician. <p>The SHARK Power Module is too hot.</p> <ul style="list-style-type: none"> Wait a few minutes and try again If this happens often, contact your dealer.
2	Battery	<p>The battery voltage is too low or too high.</p> <ul style="list-style-type: none"> Check the batteries and the cables. Batteries may be empty: charge the batteries. Batteries may be overcharged: <ul style="list-style-type: none"> if driving downhill, slow down or turn on the lights, if fitted. Batteries may be damaged: contact your dealer. <p>If this fault occurs during battery charging, the battery charger is defective or not adjusted correctly.</p> <ul style="list-style-type: none"> Contact your dealer <p>If this fault occurs during when you stop or when you travel down a slope, and the batteries are not full, the battery connector may make intermittent contact.</p> <ul style="list-style-type: none"> Check the battery cables and connectors.
3	Motor 1 (right)	<p>The motor is not connected to the SHARK, or there is a short-circuit in the motor connection.</p> <ul style="list-style-type: none"> The motor brushes may have lost connection. Turn the wheels of the chair to reconnect the motor brushes, and then turn the SHARK off and on. If this happens often, the motors may be faulty. Check that the motor cables are not loose or damaged. Contact your dealer.
4	Motor 2 (left)	
5	Parkbrake 1 (right)	<p>The parkbrake has been released manually.</p> <ul style="list-style-type: none"> Enable the parkbrake, and then turn the SHARK off and on. <p>The parkbrake is not connected to the SHARK, or there is a short-circuit in the parkbrake connection.</p> <ul style="list-style-type: none"> Check that the motor cables are not loose or damaged. Contact your dealer.
6	Parkbrake 2 (left)	
9	Missing Power Module	<p>A communication error between the Remote and the Power Module.</p> <ul style="list-style-type: none"> Batteries may be completely empty: charge the batteries. Batteries may be damaged: contact your dealer. Check that the SHARK Bus cable is not loose or damaged. Contact your dealer.
All Other	Internal fault	<ul style="list-style-type: none"> Contact your dealer.

These flash code descriptions are aimed at end users. For a more detailed flash code description see the installation manual of the SHARK Power Module.

9. Using the Seat Function Button (REMD11 & REMD21 Only)

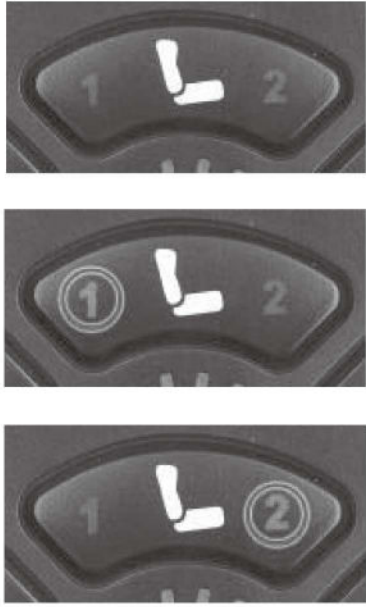
	<p>Two seat functions are available for individual adjustment and are accessed via the Seat Function Button.</p> <p>Press the Seat button once to toggle the control unit from Drive mode to Seat mode. Seat Function 1 will be active as noted by the amber coloured "1" LED.</p> <p>To adjust Seat Function 1, use the joystick Forward/Reverse.</p> <p>To access Seat Function 2, either press the Seat Function Button again or move the joystick right. The amber coloured "2" LED will light. Use the joystick Forward/Reverse to set the Seat Function 2 adjustments. Moving the joystick left/right while in Seat Mode toggles between Seat Function 1 and Seat Function 2.</p> <p>Pressing the Seat Function Button again (3 presses are a complete cycle) puts SHARK back in Drive Mode. Use the joystick to control speed and direction as normal.</p>
--	---

DK-REMD 11 Controller Operation

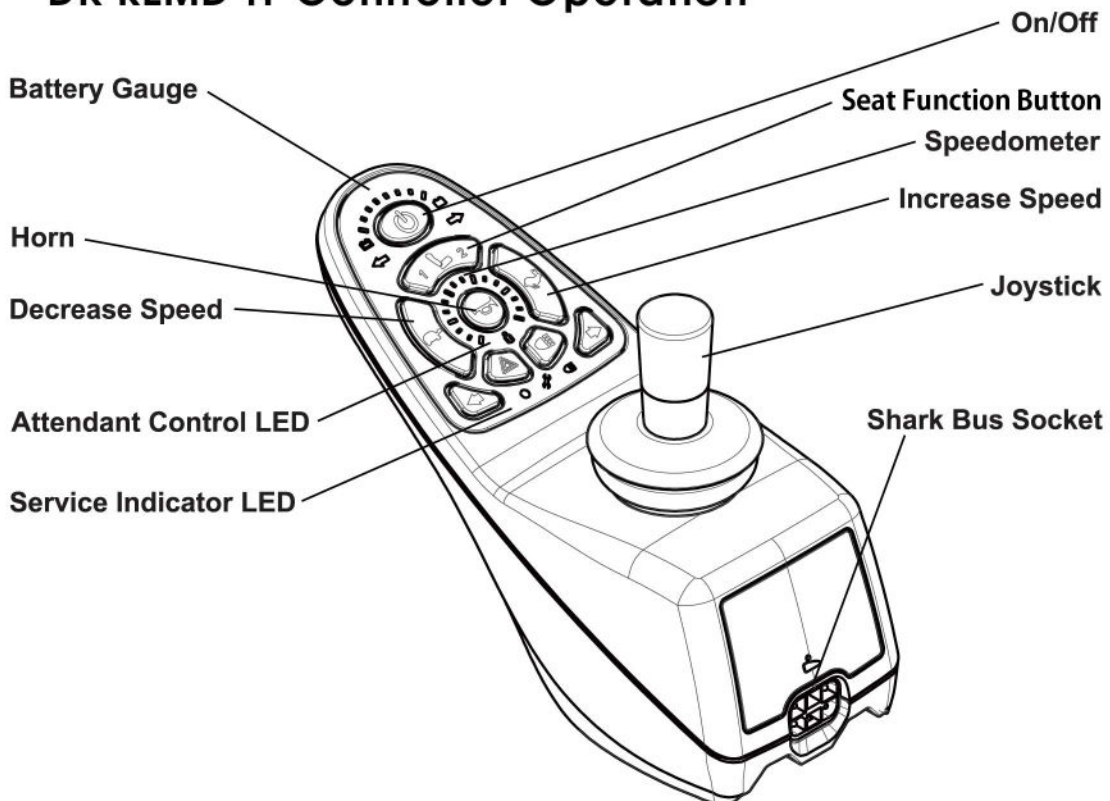

Dynamic Shark Controller Operation:

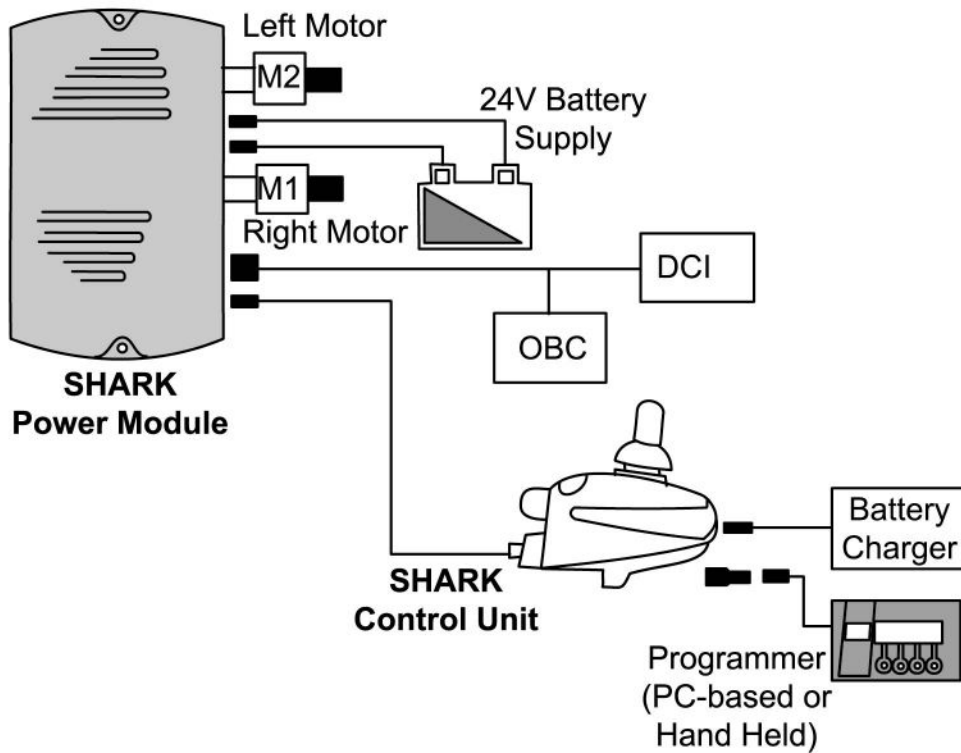

Shark Controller Introduction

The Shark Controller Unit

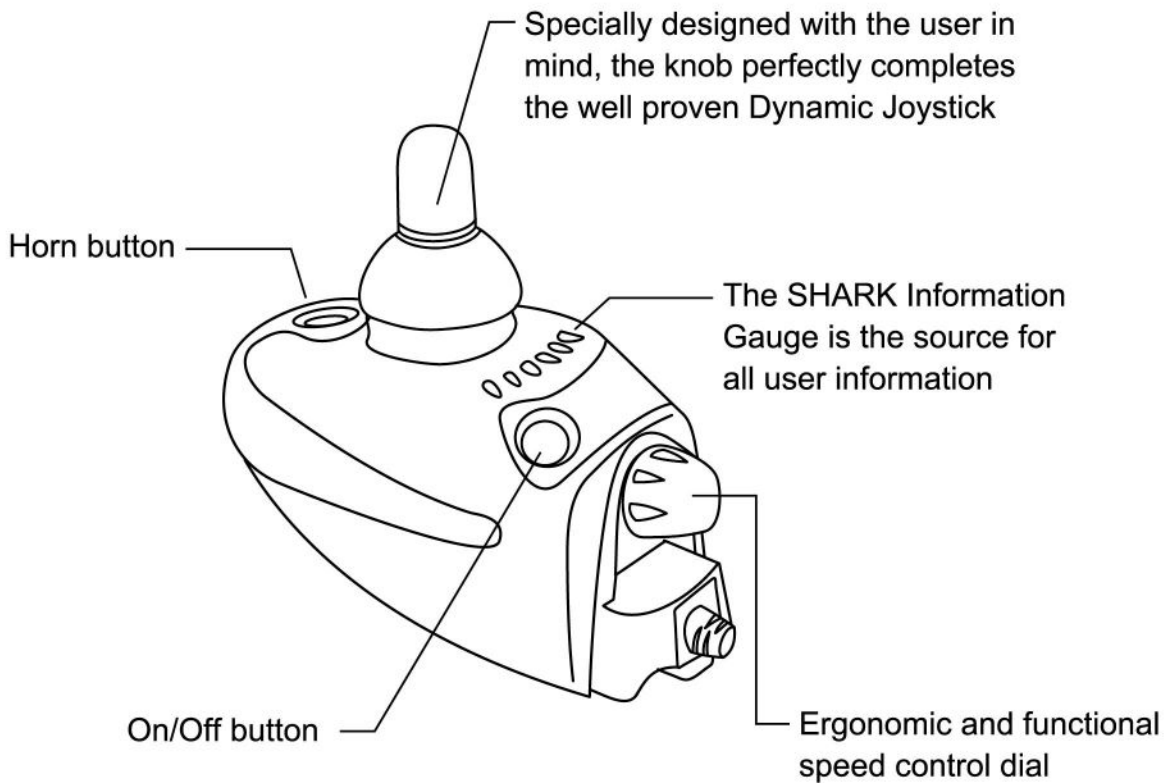

The Shark Information Gauge

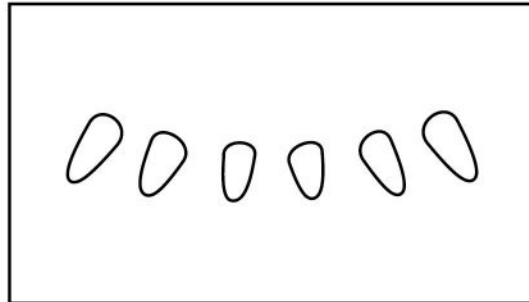

The SHARK Information Gauge is the primary source of user feedback. It displays every possible status that SHARK may have, including;







- SHARK Power ON

True state-of-battery-charge, including notification of when the battery desperately requires charging.

- **Any green** LED's lit indicates well-charged batteries.
- If only **amber and red** LED's are lit, the batteries are moderately charged. Recharge before undertaking a long trip.
- If **only red** LED's are lit, the batteries are running out of charge. Recharge as soon as possible.

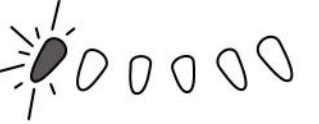
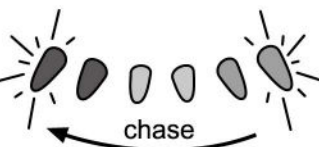
- SHARK Lock Mode countdown
- Program, inhibit or charge modes
- Fault indication (Flash Codes)

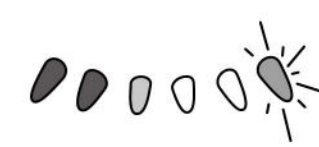
The following table indicates what the gauge will display for any given state.

Display	Description	This means...	Notes
	All LED's OFF	Power is OFF	
	All LED's ON steady	Power is ON	Less LED's imply a reduced battery charge.
	Left RED LED is flashing	Battery charge is low	The batteries should be charged as soon as possible.
	Right to left 'chase'	SHARK is being brought out of Lock mode	To unlock SHARK, press the Horn button twice with in 10 seconds.
	Left to right 'chase' alternating with steady display	SHARK is in programming, inhibit and/or charging mode	The steady LED's indicate the current state of battery charge.
	Right GREEN LED is flashing	SHARK is in SPEED LIMIT mode	The current state of battery charge will be displayed at the same time.
	All LED's flashing slowly	SHARK has detected an Out Of Neutral At Power Up (OONAPU) condition	Release the joystick back to neutral.
	All LED's flashing quickly	SHARK has detected a fault	SHARK uses Flash Codes to indicate faults. Refer to the Diagnostics section for further information about fault diagnostics.

The Shark Communications Bus

The SHARK Power Module communicates to the Control Unit through the SHARK Communications Bus. The Bus also supplies power to the Control Unit. The connector is 'keyed' and can only be plugged in one way - the control Unit symbol on top of the plug should be facing up.

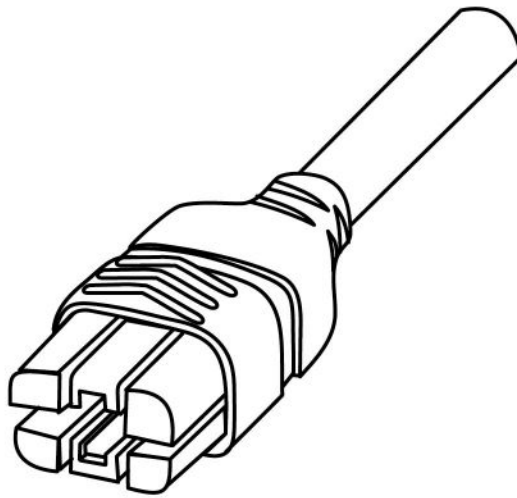

Turning the Power ON

	<p>Press the Power button.</p> <p>All indicators will light briefly.</p> <p>Either the current battery charge or Lock Mode will then be indicated.</p>
---	--

Turning the Power OFF

	<p>Press the Power button.</p> <p>The LED's will turn off.</p>
---	--



The Power button can also be used to turn SHARK off in case of an emergency.

	<p>After a certain amount of time with no joystick movement SHARK will automatically turn itself off. Sleep mode will not be entered while programming.</p> <p>Any button press (or joystick movement if Wakeup style has been set to "Joystick or Button") will bring the system out of sleep mode.</p>
---	--

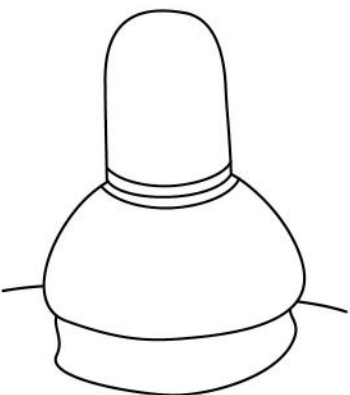
	<p>Moving the joystick will cause the powerchair to drive in that direction. The amount of joystick movement will determine the speed that the powerchair will move in that direction.</p>
--	--

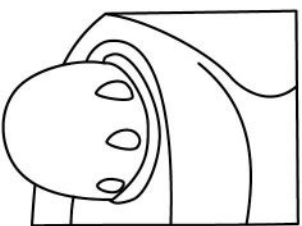
	<p>A user may adjust the top speed of their powerchair to suit their preference or environment by turning the speed control dial.</p> <p>Simply turn the dial fully clockwise to travel at top speed when the joystick is pushed fully forward. The top speed progressively reduces as the dial is turned counter-clockwise.</p>
---	--

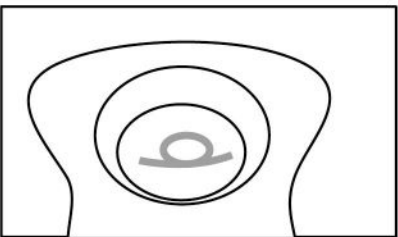
	<p>Press the Horn button.</p> <p>The horn will sound for as long as the button is pressed.</p>
---	--



Flash codes indicate the nature of an abnormal condition directly from the SHARK Information Gauge. Without the use of any servicing tools, the condition can be simply diagnosed.

Flash Code	Description	
1	User Fault	Possible stall timeout or user error. Release the joystick to neutral and try again.
2	Battery Fault	Check the batteries and cabling. Try charging the batteries. Batteries may require replacing.
3	Right Motor Fault	Check the right motor, connections and cabling.
4	Left Motor Fault	Check the left motor, connections and cabling.
5	Right Park Brake Fault	Check the right park brake, connections and cabling.

Flash Code	Description	
6	Left Park Brake Fault	Check the left park brake, connections and cabling.
7	SHARK Control Unit Fault	Check the SHARK Communications Bus connections and wiring. Replace the Control Unit.
8	SHARK Power Module Fault	Check SHARK connections and wiring. Replace the Power Module.
9	SHARK Communications Fault	Check SHARK connections and wiring. Replace the SHARK Control Unit.
10	Unknown Fault	Check all connections and wiring. Consult a service agent.
11	Incompatible Control Unit.	Wrong type of Control Unit connected. Ensure the branding of the Power Module matches that of the Control Unit.

■ VR2 Controller Operation:

The VR2 control system has two versions of the front control panel - with and without actuator control. Most of the controls are common to both versions, however, the actuator buttons are only included on VR2 control systems with seat actuator control. Each of the controls are explained within this section.

VR2 USER CONTROLS

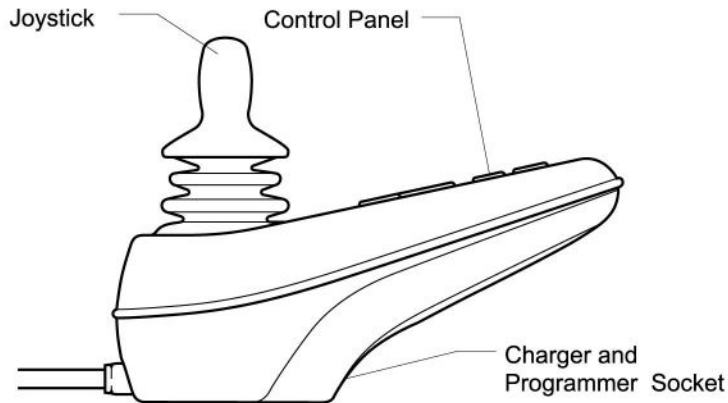

Front Control Panel Details

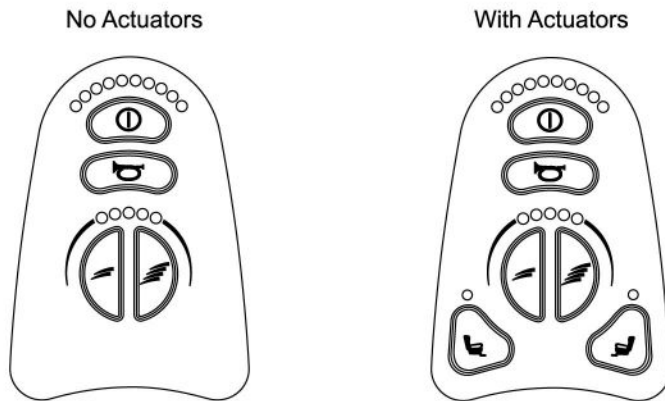

VR2 CONTROL BUTTONS

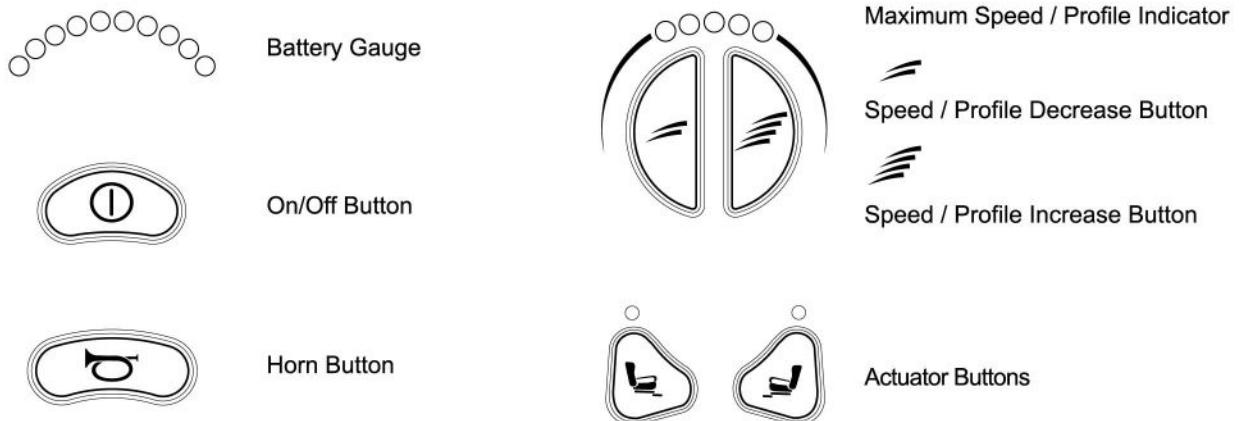

On/Off Button and Battery Gauge

The on/off button applies power to the control system electronics, which in turn supply power to the wheelchair's motors. Do not use the on/off button to stop the wheelchair unless there is an emergency. (If you do, you may shorten the life of the wheelchair drive components).

The battery gauge shows you that the wheelchair is switched on. It also indicates the operating status of the wheelchair. Details are given in section 1.

1 Control System Status indication

The battery gauge and maximum speed / profile indicator show the status of the control system.

A number of supposedly defective control systems returned to us are subsequently found to operate correctly. This indicates that many reported faults are due to wheelchair problems rather than the control system.

1.1 Battery Gauge is Steady

This indicates that all is well.

1.2 Battery Gauge Flashes Slowly

The control system is functioning correctly, but you should charge the battery as soon as possible.

1.3 Battery Gauge steps Up

The wheelchair batteries are being charged. You will not be able to drive the wheelchair until the charger is disconnected and you have switched the control system off and on again.

1.4 Battery Gauge Flashes Rapidly (even with the joystick released)

The control system safety circuits have operated and the control system has been prevented from moving the wheelchair.

This indicates a system trip, i.e. the VR2 has detected a problem somewhere in the wheelchair's electrical system. Please follow this procedure.

- Switch off the control system.
- Make sure that all connectors on the wheelchair and the control system are mated securely.
- Check the condition of the battery.
- If you can't find the problem, try using the self-help guide given in section 1.6.
- Switch on the control system again and try to drive the wheelchair. If the safety circuits operate again, switch off and do not try to use the wheelchair.

Contact your service agent.













1.5 Self-Help Guide

If a system trip occurs, you can find out what has happened by counting the number of bars on the battery gauge that are flashing.

Below is a list of self-help actions. Try to use this list before you contact your service agent. Go to the number in the list which matches the number of flashing bars and follow the instructions.

If the problem persists after you made the checks described above, contact your service agent.

* If the programmable parameter, Motor Swap has been enabled, then left and right hand references in this table will need transposing.

- | | |
|---|--|
|  | The battery needs charging or there is a bad connection to the battery. Check the connections to the battery. If the connections are good, try charging the battery. |
|  | The left hand motor* has a bad connection. Check the connections to the left hand motor. |
|  | The left hand motor* has a short circuit to a battery connection. Contact your service agent. |
|  | The right hand motor* has a bad connection. Check the connections to the right hand module. |
|  | The right hand motor* has a short circuit to a battery connection. Contact your service agent. |
|  | The wheelchair is being prevented from driving by an external signal. The exact cause will depend on the type of wheelchair you have, one possibility is the battery charger is connected. |
|  | A joystick fault is indicated. Make sure that the joystick is in the center position before switching on the control system. |
|  | A control system fault is indicated. Make sure that all connections are secure. |
|  | The parking brakes have a bad connection. Check the parking brake and motor connections. Make sure the control system connections are secure. |
|  | An excessive voltage has been applied to the control system. This is usually caused by a poor battery connection. Check the battery connections. |
|  | A communication fault is indicated. Make sure that joystick cable is securely connected and not damaged. |
|  | An Actuator trip is indicated. If more than one actuator is fitted, check which actuator is not working correctly. Check the actuator wiring. |

1.6 Slow or sluggish movement

If the wheelchair does not travel at full speed or does not respond quickly enough, and the battery condition is good, check the maximum speed setting. If adjusting the speed setting does not remedy the problem then there may be a non-hazardous fault. Contact your service agent.

1.7 Maximum Speed / Profile Indicator is Steady

The display will vary slightly depending on whether the control system is programmed to operate with drive profiles.

1.7.1 Maximum Speed Indication

The number of LEDs illuminated shows the maximum speed setting. For example, if the setting is speed level 4, then the four left hand LEDs will be illuminated.

1.7.2 Profile Indication

The LED illuminated shows the selected drive profile. For example, if drive profile 4 is selected, then the fourth LED from the left will be illuminated.

1.8 Maximum Speed / Profile Indicator Ripples Up and Down

This indicates the control system is locked.

1.9 Maximum Speed / Profile Indicator Flashes

This indicates the speed of the wheelchair is being limited for safety reasons. The exact reason will depend on the type of wheelchair, however, the most common cause is that the seat is in the elevated position.

VR2 POWER MODULE CONNECTIONS

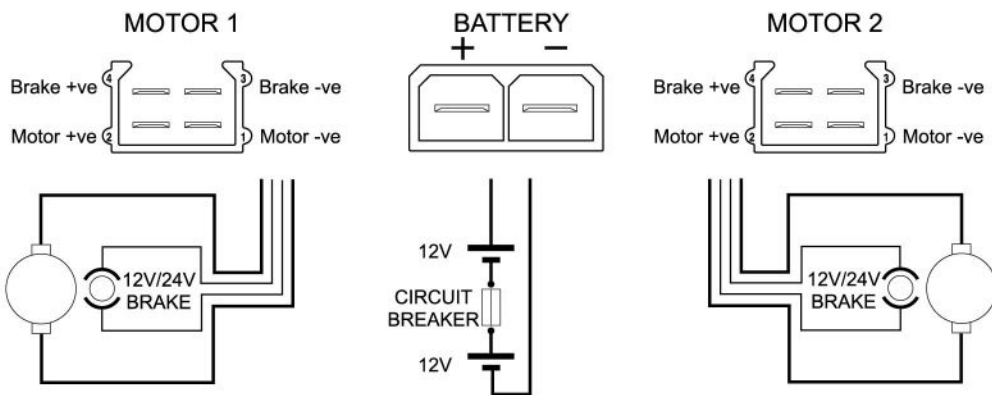
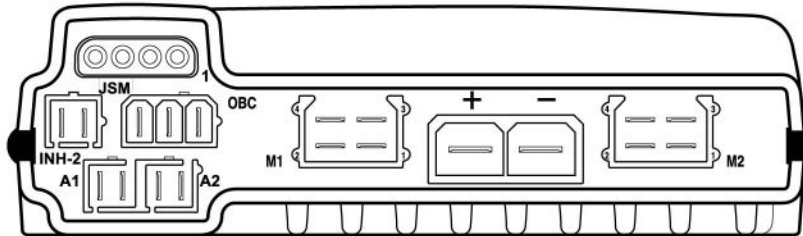

INHIBIT 2



INH-2	Function
1	0V
2	Inhibit 2

ON-BOARD CHARGER

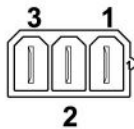

OBC	Function
1	Battery +ve
2	Inhibit 3
3	0V

ACTUATORS

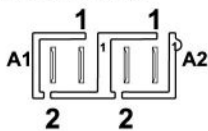

Joystick Movement	Pin 1	Pin 2	Actuator Movement
	Forward	+ve	
Backward	-ve	+ve	Channel Down

LiNX Controller Operation

The Remote

There are two versions of the LiNX LE System Remote, namely the REM050, and REM060. Figure 36, and Figure 37, show the main features of these Remotes. These features are described in more detail in the following sections.

Warning: Users should be aware that the surface of the Remote can potentially get hot when it is exposed to strong sunlight for long periods.



Figure 36: The Remote REM050: user interface and connectors



Figure 37: The Remote REM060: user interface and connectors

Power up / down



Figure 38: Power OFF

To switch **ON** the LiNX LE System, press the Power button. The Power button is the only user input that can activate the system.

If there is no fault with the system, the Status indicator (through the Power button) will light up green, and the Battery Gauge will display the current battery status.

If there is a fault with the system when powering up, the status indicator will indicate the fault with a series of red flashes (see section 10 Diagnostics). If the fault is one that prevents the system from driving, then the battery gauge will flash continuously.



Figure 39: Power ON

To switch **OFF** the system, press the Power button; the system will power down and the Status indicator will switch off.

The Power button is also used to perform an EMERGENCY STOP. See next section.

The Power button is also used to lock the system.

Emergency stop

If the user needs to stop the wheelchair quickly, the Power button can be pressed to perform an EMERGENCY STOP. The wheelchair will come to a halt quickly.

Drive inhibit indication

Drive inhibit mode is indicated by the battery gauge with a right-to-left chase sequence.

The chase sequence starts with the green LED on the right-hand side, and one-by-one, each LED will switch on and then off. When the sequence completes at the left-most red LED, it begins again at the right-hand side.

The chase sequence continues until the error condition has been cleared.

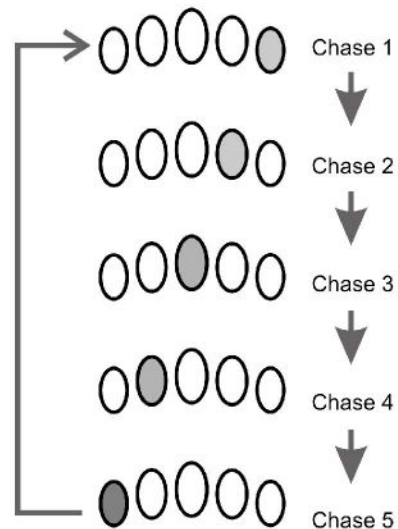

Figure 40: Drive inhibit chase sequence

OONAPU

OONAPU (“**Out Of Neutral At Power Up**”) is a safety feature that prevents accidental movement of the wheelchair, either when powering up, or when the wheelchair comes out of an inhibit state.

If the LiNX LE System is turned on (or comes out of an inhibit state) while the joystick is not in the centre position, an OONAPU **warning** is displayed. During an OONAPU warning, the battery gauge LEDs will flash continually to alert the user, and the chair will not drive. If the joystick is returned to the centre position within five seconds, the warning will clear and the wheelchair will drive normally.

However, if the joystick remains out of neutral for longer than five seconds, an OONAPU **error** will occur; the error is displayed by the Status indicator flashing red, and the chair will not drive. To clear the error, return the joystick to the neutral position and power the unit off and then on again.

The joystick

The joystick controls the direction and speed of the wheelchair.

When the joystick is deflected from the centre position, the wheelchair will move in the direction of the joystick movement.

The speed of the wheelchair is proportional to the joystick deflection, so that the further the joystick is moved from the centre position, the faster the wheelchair will travel.



Figure 41: The joystick

Controlling maximum speed



Figure 42: The speed dial

The speed dial allows the user to limit the maximum speed of the wheelchair (that is, the speed when the joystick is fully deflected) to suit their preference and environment.

The dial offers 10 discrete steps between the lowest speed (dial set to the left) and the highest speed (dial set to the right).

As a visual reminder, a speed symbol (shown left) is positioned just below the speed dial to indicate the low and high positions of the speed dial.



Figure 43: The speed symbol

The horn



Figure 44: The horn button (REM050 top, REM060 bottom)

The REM050's Horn button is located above the Power button. The REM060's Horn button is located below the Power button. Press the Horn button to sound the horn. The horn will sound for as long as the Horn button is pressed.

The Horn button is also used for unlocking a locked system - see below for more details.

The lock function

The lock function is used, primarily, to restrict who can use the system, but also can help prevent unintentional use of the controls for when the system is not required for any length of time.

When a system is locked (see below), the system is powered down, and the user controls are not responsive. If the power button is pressed when the system is locked, the locked status is displayed to the user by the Battery Gauge.

To unlock the system, an unlock sequence must be performed (see below) by the user within a specific timeframe. If the sequence is not performed correctly, within the timeframe, the system remains locked.



Figure 45:
Power OFF

To **lock** the system, press and hold the Power button for 4 seconds.

When entering the locked state, the battery gauge will indicate the transition by flashing LEDs 1, 3, and 5 (far left, middle, and far right) 3 times.

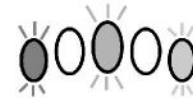
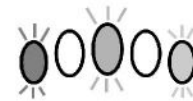

Figure 46:
Power ON

To **unlock** the system, press the Power button once, and then, press the Horn button twice — the Horn button must be pressed twice within 10 seconds of pressing the Power button.

If the user implements the unlock sequence incorrectly, or the Power button is pressed again before the unlock sequence is complete, the system will return to the locked state.

During an unlock attempt, the battery gauge will indicate the system is in a Locked state by flashing LEDs 1, 3, and 5 (far left, middle, and far right) until either the system is powered off, unlocked, or the Sequence Timeout is reached.



The battery gauge

The battery gauge comprises five different LEDs (1 x RED, 2 x AMBER, 2 x GREEN), situated above the Remote's Horn button. The number of LEDs lit depends on the status of the battery, as shown below.

The battery gauge LEDs are also used to display charging information. See Battery charging for more details.

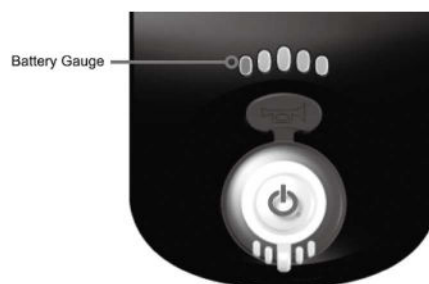

Figure 47: The battery gauge

Normal operation

Battery Gauge

Battery Level



Fully charged



Consider charging battery



Battery needs charging

Figure 48: Battery gauge operation

High voltage warning



A high voltage warning is indicated by all LEDs on, and the green LEDs flashing. This occurs when the battery voltage level has risen above the high voltage warning.

Figure 49: High voltage warning Warning.

Low voltage warning



A low voltage warning is indicated with the left-most LED flashing. This occurs when the battery voltage level has decreased below its low voltage warning.

Figure 50: Low voltage warning

Charge the battery immediately - it is being damaged.

Cut-off voltage



Figure 51: Cut-off voltage

When the battery voltage decreases below the battery cut-off voltage:

- the status indicator will flash (Flash code 2)
- the first (red) LED will flash on the battery gauge
- the horn will sound once every 10 seconds

The status indicator



The status indicator is located underneath the power button. When the LiNX LE System is not powered up, the status indicator is not lit.



When the LiNX LE System is powered up, and there are no faults with the system, the status indicator will be lit green.



If, when powered up, there is a fault with the system, then the status indicator will flash red. The number of flashes will indicate the type of error. For flash codes, see section 10 Diagnostics.

Figure 52: The status indicator

Battery charging

The battery charging socket of the LiNX System is a 3-pin XLR type, located on the LiNX Remote.

To charge the wheelchair's battery, plug the battery charger into the Remote's XLR socket.

The Battery Gauge will indicate the system is connected to the charger by cycling between a left-to-right chase sequence, and then displaying the approximate battery charge state at the end of the chase sequence.

The LE system does not have to be powered up when charging the battery, however, if it is not powered up, then the battery gauge will not display the charging state/ chase sequence.

The battery charger's connector plug must be wired with a Drive Inhibit connection, as shown below.

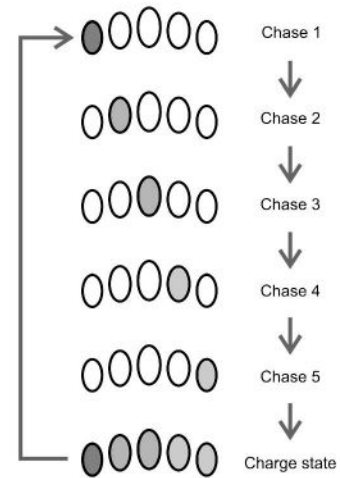
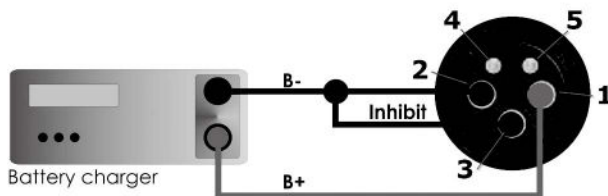

Figure 53: Battery charging chase sequence

Pin	Signal
1	Battery Positive (B+)
2	Battery Negative (B-)
3	Drive Inhibit
4	Communications Bus High
5	Communications Bus Low

The Drive Inhibit signal ensures that the wheelchair does not drive when connected to the charger. This signal must be provided within the battery charger plug as a connection between pin 2 and pin 3. Ensure that the battery charger is compatible with this configuration before connecting it to the charging socket.



Warning:

The maximum charging current for the LiNX LE System is 8 A.

Error indication



Figure 129: The status indicator

If there is an error with the system when it is powered up, then the status indicator will flash red; the number of flashes will indicate the type of error.

The table below describes the error indication, and a few possible actions that can be taken to rectify the problem. The actions listed are not in any particular order and are suggestions only; the intention is that one of the suggestions may help you clear the problem. If in doubt, consult your supplier.

Flash code	Error description	Possible action
1	Remote / joystick error	Check cables and connectors Replace Remote
2	Network or configuration error	Check cables and connectors Check Bluetooth pairing Reconfigure the system Recharge the battery Check charger Replace modules Contact supplier
3	Left motor error	Check cables and connectors Replace Power Module Check and/or replace left motor
4	Right motor error	Check cables and connectors Replace Power Module Check and/or replace right motor
5	Left park brake error	Check cables and connectors Check left park brake is released
6	Right park brake error	Check cables and connectors Check right park brake is released
7	Module error (other than Remote)	Check cables and connectors Check modules Replace LiNX Access Key Replace Power Module Recharge battery If the chair stalled, reverse away or remove obstacles, or if the chair was moved while turned off, cycle the power.

The error indicator may continue to flash after an error has been rectified. To clear the error indication, cycle the system's power.

Typical cabling installation

A typical LiNX LE installation will comprise the following:

- A 24V battery supply and circuit breaker connected to the battery connector
- A motor and park brake connected to the M1 connector
- A motor and park brake connected to the M2 connector
- A LiNX remote module connected to the communications bus connector

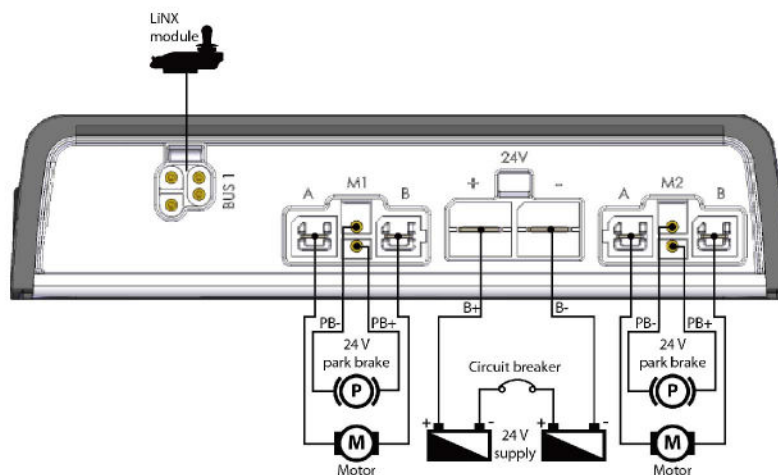

Figure 4: Typical cabling installation LiNX LE series

LiNX Communications Bus

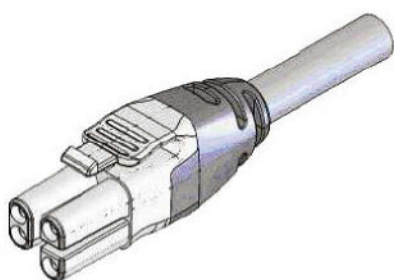

Figure 21: LiNX Communications Bus loom

The LiNX LE System Power module communicates with the Remote through the LiNX Communications Bus

LiNX Communications Bus Connector		
	Pin	Function
	1	Battery Negative (B-)
	2	Communications Bus Low
	3	Communications Bus High
	4	Battery Positive (B+)

Figure 14: LiNX Communications Bus connector

► Operating your powerbase wheelchair ◀

Batteries and Charging

Your Power Wheelchair uses two long-lasting, 12-volt batteries. These batteries are sealed, maintenance free, deep-cycle batteries. Since they are sealed, there is no need to check the electrolyte (fluid) level. Deep-cycle batteries are designed to handle a deep discharge. Though they are similar in appearance to automotive batteries, they are not interchangeable. Automotive batteries are not designed to handle a long, deep discharge, and are also unsafe for use in power wheelchairs.

WARNING! Battery posts, terminals and related accessories contain lead and lead compounds. Wash hands after handling.

BATTERY BREAK-IN

To break in your power wheelchair new batteries for maximum efficiency:

1. Fully recharge any new battery prior to initial use. This will bring the battery up to about 90% of its peak performance level.
2. Run your power wheelchair about the house and yard. Move slowly at first, and do not stray too far until you become accustomed to the controls and break in the batteries.
3. Give the batteries another full charge of 8 to 14 hours and operate the power wheelchair again. The batteries should now perform at over 90% of their potential.
4. After four or five charging cycles, the batteries will top off at 100% charge and last for an extended period.

IMPORTANT INFORMATION ABOUT BATTERIES

A fully charged deep-cycle battery provides reliable performance and extended battery life. Keep your batteries fully charged whenever possible. Batteries that are regularly discharged, infrequently charged, or stored without a full charge may be permanently damaged, causing unreliable operation and limited battery life.

If you do not use your power wheelchair regularly, we recommend maintaining battery vitality by charging the batteries at least once a week.

Note: If you are storing a power wheelchair for an extended period of time, you may wish to block the unit up off the ground with several boards under the frame.

This keeps the tires off the ground to prevent the possibility of flat spots developing.

If you intend to use public transportation while using your power wheelchair, you must contact the transportation provider in advance to determine their specific requirements.

Sealed Lead Acid and Gel Cell batteries are designed for application in wheelchairs and in other mobility vehicles. Generally, Sealed Lead Acid batteries that are marked as "Non-Spill" are safe for all forms of transportation such as aircraft, buses, and trains. We suggest that you contact your transportation provider to determine specific requirements of transportation and packaging.

If you wish to use a freight company to ship the power wheelchair to your final destination, repack the power wheelchair in the original shipping container and ship its batteries in separate boxes.

Charging Your Batteries





The battery charger is one of the most important parts of your power wheelchair. Optimize your power wheelchair performance by charging the batteries safely, quickly, and easily. Use only the charger supplied with the vehicle.

Charging Procedures

1. Keep charger output plug inserted into the charging socket in the front of the controller before having the charger input plugged into an electrical outlet.
2. Follow the instructions on the front panel of the charger for operating and learn the meanings of the different indicators accordingly.
3. Minimum charging time varies depending on battery condition and discharge level. It is recommended to charge the batteries overnight.

NOTE: The specially designed charger assures that excess power is not consumed regardless of how long it is switched on, and connected to the batteries.

4. Once charging is complete, disconnect the charger from the electrical outlet and then disconnect the charger from the controller socket. Do not leave the charger connected to controller when input power is disconnected. It is dangerous and will jeopardize the power charging to the batteries.

IEC SYMBOLS	
	Caution, attention or consult accompanying documents.
	Alternating Current
	Type BF Equipment
	Double Insulation
	No Smoking or Naked Flames

Degree of protection against ingress of water is rated as IPx0.

Serialization format for products	
	
1	The first digit is the last one digit of the year for manufacture.
2	The second and third digits are the month for manufacture.
3	The fourth to seventh digits are a count of how many units were manufactured during the month.

► Warranty ◀

Limited Warranty

Corporation warrants to the original purchaser of this wheelchair product that it is free of defects in material and workmanship and that, when operated within the guidelines and restrictions of this manual, will remain so free of defects in material and workmanship for a period of 18 months from the original date of purchase.

Excluded from this warranty is failure due to negligence, abuse, accident, operation outside of rated limits, commercial or institutional use, damage / wear to upholstery or tires and improper maintenance or storage. The batteries for this wheelchair product are not supplied by Corporation; contact the battery manufacturer / supplier if warranty replacement is requested.

This wheelchair product must not be modified in any way without the express written consent of Corporation. Any such unauthorized modification could cause unreliable and / or unsafe operation and will void this warranty.

Where a failure occurs within the 18 months warranty period that is not excluded above, the failed components will be replaced with similar new or reconditioned components at sole option. Corporation will not be responsible for labor and / or shipping charges.

The foregoing warranty is exclusive and in lieu of all other warranties expressed or implied including, but not limited to, the implied warranty of merchantability and fitness for a particular purpose. Corporation will not be liable for any consequential or incidental damages whatsoever.

► Warranty Registration ◀

WARRANTY REGISTRATION

MODEL NO. _____

SERIAL NO. _____

DATE PURCHASED _____

NAME _____

ADDRESS _____

CITY _____ STATE _____ ZIP _____

DEALER NAME _____

STAMP

RETURN ADDRESS



Figure 1

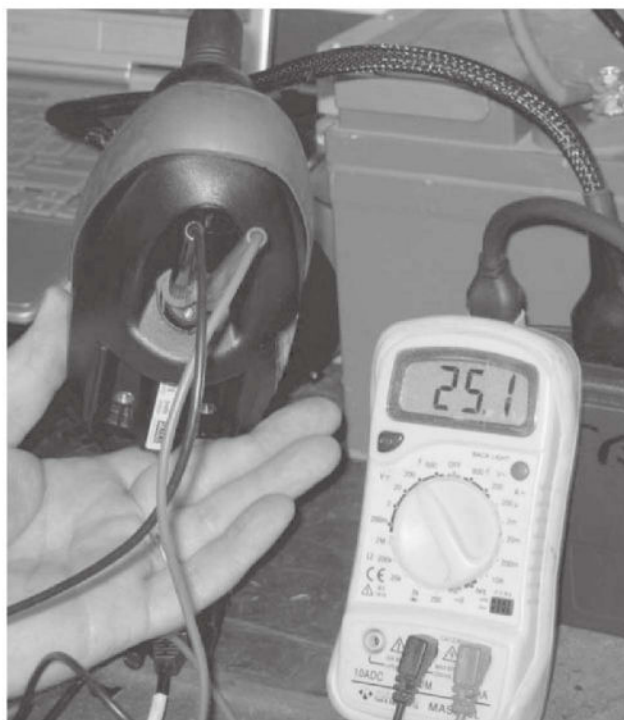

Figure 2

TROUBLESHOOTING TIPS

If your power chair or scooter is not operating properly, please take the following steps prior to calling Technical Support.

Load-test Batteries—See Figure 1

1. Attach Battery Load-tester to battery.
Observe polarity: Red is Positive—Black is Negative
2. Hold load switch on for 10 seconds. A good reading is 11.2 Volts DC, or in the Green.

Note: A Voltmeter cannot load-test batteries.

Test Voltage—See Figure 2

Utilizing a Voltmeter, place meter leads in charging port. The voltage reading should be 25 Volts DC, plus or minus 2 volts.

Note: Batteries are connected in series.

If the above tests are successful, proceed with the following test.

1. For power chairs, place gearbox levers in Freewheel.
2. Turn on controller and run in all four quadrants.
3. If troubleshooting a scooter, elevate rear wheels and run in Forward and Reverse.

If any of the tests fail, call Technical Support for assistance: 1-800-963-7487.



MERITS HEALTH PRODUCTS, INC.

www.meritsusa.com 730 N.E. 19th Place, Cape Coral, FL 33909
TEL:1-800-963-7487, 1-239-772-0579 FAX:1-239-574-2661